













Desk Assembly

SKUS: 1320400, 1320407

NEED HELP?
1-800-444-8444
warranty@rizehome.com

INCLUDED PARTS

- Desktop
1 pcs 
- Left Leg Frame
1 pcs 
- Right Leg Frame
1 pcs 
- Crossbar
1 pcs 
- 1/4 x 35mm Bolts
8 pcs 
- Lock Washers
8 pcs 
- Flat Washers
8 pcs 
- 4 x 50 Screws
2 pcs 
- Knobs
2 pcs 
- Pan-Head Bolts
2 pcs 
- Allen Wrench
1 pcs 

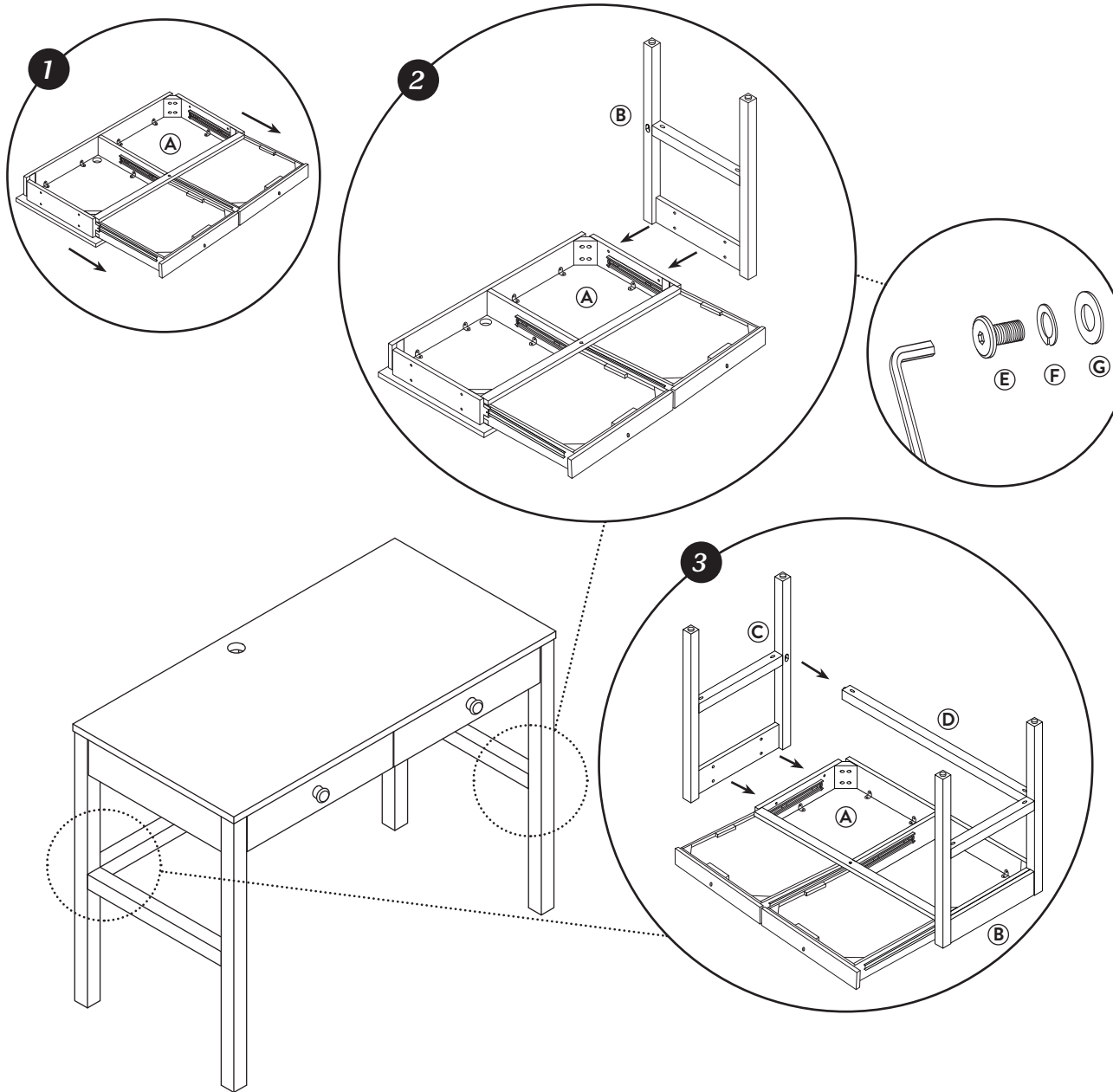

1. Place the Desktop (A) upside down, then slide out the drawers.
2. Attach Left Leg Frame (B) to Desktop (1) with four 1/4 x 35mm Bolts (E), followed by Lock Washers (F) and Flat Washers (G). Fully tighten with the Allen Wrench (K).
3. Attach Right Leg Frame (C) to Desktop (1) using four 1/4 x 35mm Bolts (E) with Lock Washers (F) and Flat Washers (G). Before tightening, insert Crossbar (D) between Leg Frames (B) and (C), ensuring screw holes face up. Fully tighten all Bolts with the Allen Wrench (K).

CONTINUE TO NEXT PAGE →



Desk Assembly











SKUS: 1320400, 1320407

NEED HELP?

1-800-444-8444

warranty@rizehome.com

INCLUDED PARTS

- (A) Desktop
1 pcs 
- (B) Left Leg Frame
1 pcs 
- (C) Right Leg Frame
1 pcs 
- (D) Crossbar
1 pcs 
- (E) 1/4 x 35mm Bolts
8 pcs 
- (F) Lock Washers
8 pcs 
- (G) Flat Washers
8 pcs 
- (H) 4 x 50 Screws
2 pcs 
- (I) Knobs
2 pcs 
- (J) Pan-Head Bolts
2 pcs 
- (K) Allen Wrench
1 pcs 

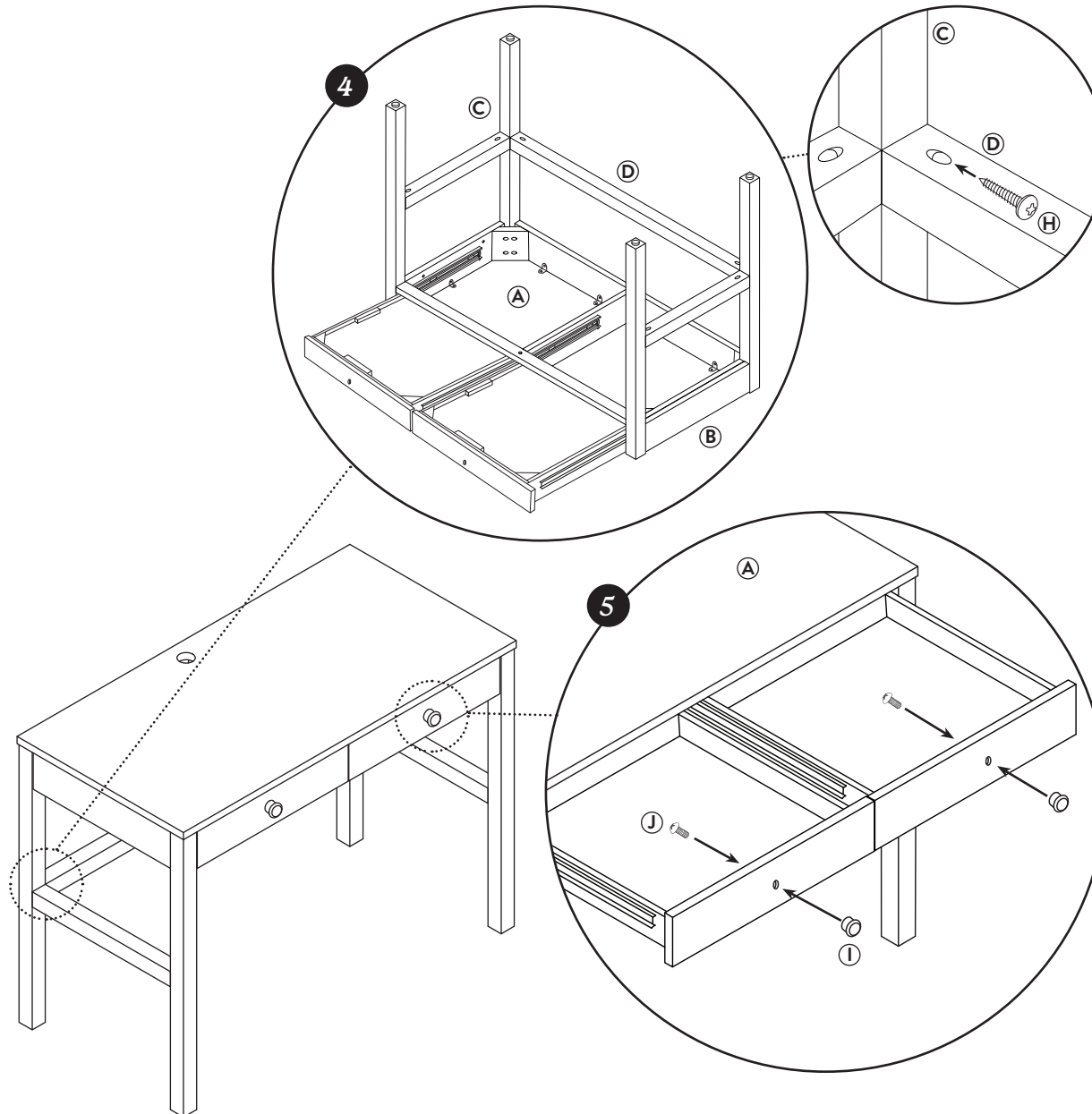

4. Secure Crossbar (D) to Leg Frames (B) and (C) with 4 x 50 Screws (H), tightening fully with a screwdriver.
5. Carefully turn the desk upright, pull out each drawer, and attach Knobs (I) with Pan-Head Bolts (J) using a screwdriver.

Your desk is now fully assembled!